



RELIANCE™

fall protection



INSTRUCTIONS FOR USE

42XXXXX Series Micro-Loc™ Self Retracting Lanyards

Complies with current ANSI Z359.14 and all applicable OSHA regulations and requirements.

Reliance Industries
P.O. Box 2046
Deer Park, TX 77536

Phone: 281-930-8000
Toll Free: 888-362-2826
Fax: 281-930-8666



CONTENTS

DESCRIPTION	3
PRODUCT SPECIFICATIONS	7
APPLICATION	7
A. PURPOSE	7
1) PERSONAL FALL ARREST	8
B. USE LIMITATIONS	8
1) CAPACITY	8
2) FREE FALL	8
3) FALL CLEARANCE	9
4) SWING PENDULUM FALLS	11
5) CHEMICAL HAZARDS	12
6) HEAT	12
7) CORROSION	12
8) ELECTRICAL HAZARDS	12
9) MOVING MACHINERY	12
10) SHARP EDGES AND ABRASIVE SURFACES	12
11) WEAR AND DETERIORATION	12
12) IMPACT FORCES	12
SYSTEMS REQUIREMENTS	13
C. COMPATIBILITY OF SYSTEM PARTS	13
1) COMPATIBILITY OF COMPONENTS AND SUBSYSTEMS	13
2) COMPATIBILITY OF CONNECTORS	13
3) ANCHORAGES AND ANCHORAGE CONNECTORS	14
INSTALLATION PROCEDURE	14
A. CONNECTING THE SRL TO AN ANCHOR POINT	14
B. CONNECTING THE SRL TO A HARNESS	15
C. CONNECTING TWIN SRL'S TO A HARNESS	15
D. PREPARATION FOR USE	17
E. INSPECT PRIOR TO USE	17
F. PLAN SCOPE OF WORK TO BE PERFORMED ANALYSIS	17
CARE OF THE MICRO-LOC	19
INSPECTIONS	19
A. INSPECTION FREQUENCY	19
B. INSPECTION PROCEDURE	19
TRAINING	21
RESCUE PLANNING	21
SERVICING	22
GUARDING AGAINST APPLICATION FAILURE	22
WARNINGS AND LIMITATIONS	22
LABELING	23
NOTES	25
INSPECTION RECORD	26
PART NUMBER LIST	27
WARRANTY STATEMENT	27

Instructions for Use

User Instructions

Reliance Micro-Loc™ Self Retracting Lanyards

This manual is intended to meet the Manufacturer's Instructions as required by the current ANSI Z359.14 ,and should used as part of an employee training program as required by OSHA.

WARNING

This product is one part of a personal fall arrest, restraint, work positioning, personnel riding, climbing, or rescue system. Without the other necessary components in such sub-systems the Self Retracting Lanyard itself serves no useful purpose. The user must follow the manufacturer's instructions for each component of the system. These instructions must be provided to the user before using this product and retained for ready reference by the user. The user must read, understand (or have explained), and heed all instructions, labels, markings and warnings supplied with this product and with those products intended for use in association with it before using this equipment. Manufacturer's instructions must be followed for proper use and maintenance of this equipment. National standards and state, provincial and federal laws require the user to be trained before using this product. This manual can be used as part of a such a user safety-training program that is appropriate for the user's occupation.

IMPORTANT: Alterations or misuse of this product or failure to follow instructions may result in serious injury or death. If you have questions on the use, care, or suitability of this equipment for your application, contact Reliance Fall Protection for information.

DESCRIPTION

The Micro-Loc™ Self Retracting Lanyard (SRL) is designed to be a component in a personal fall arrest systems (PFAS). It may be used in most situations where a combination of worker mobility and fall protection is required (i.e. inspection work, general construction, maintenance work, steel stick work, etc.). The Micro-Loc™ SRL is designed for use by a single person weighing up to 400 lbs (180kg) including clothing, tools and equipment. Micro-Loc™ Self Retracting Lanyard features a cam-action pawl system ensuring positive lock-up even in the most demanding environments. The SRL's are mounted at the dorsal D-ring location of the users full body harness. Models are available in both single and twin SRL configurations which incorporate Pelican™, rebar snap hooks, tie-back hooks and lightweight carabiners.

Identifying Components of Micro-Loc™ Self Retracting Lanyards

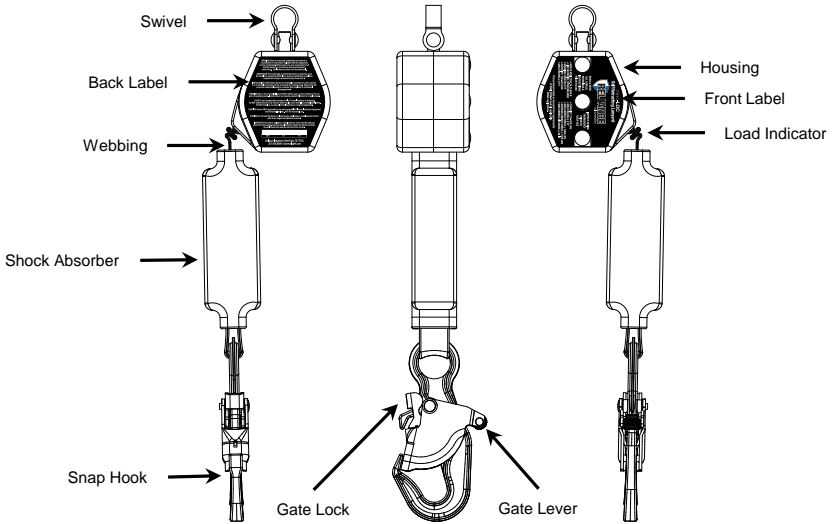

Figure 1 - 4255006-1 Single

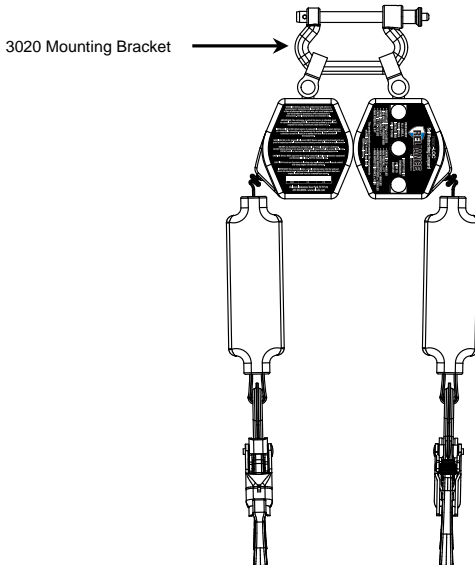

Figure 2 - 4265006-1 Twin

Instructions for Use

Identifying Components of Micro-Loc™ Self Retracting Lanyards

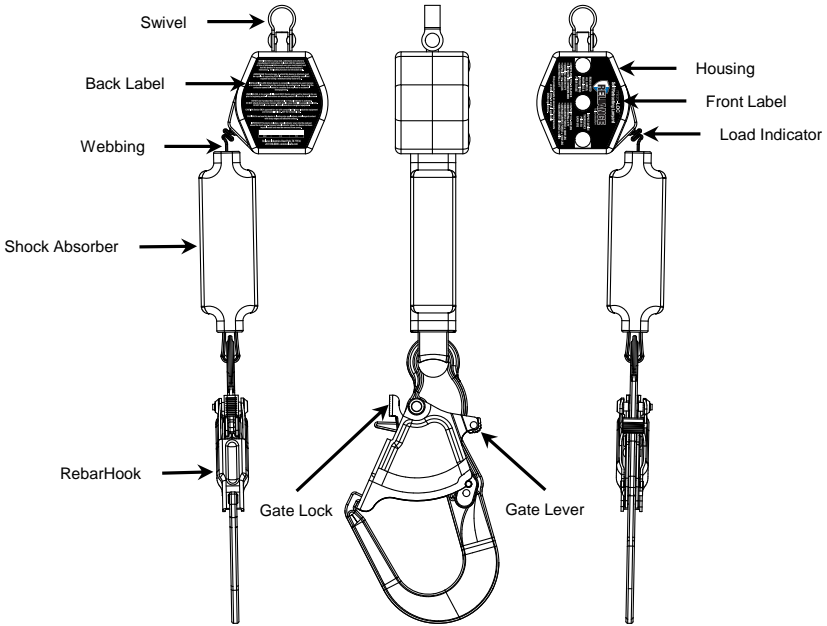

Figure 3 - 4256006-1 Single

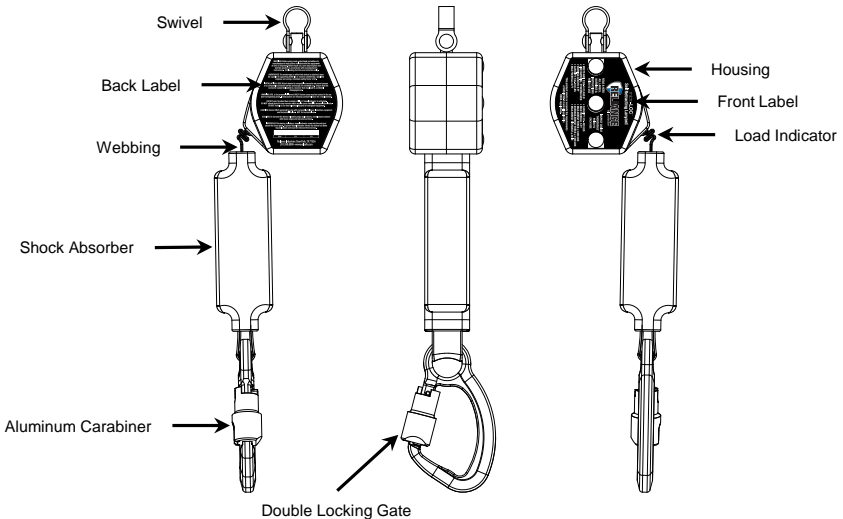

Figure 4 - 4258006-1 Single

Identifying Components of Micro-Loc™ Self Retracting Lanyards

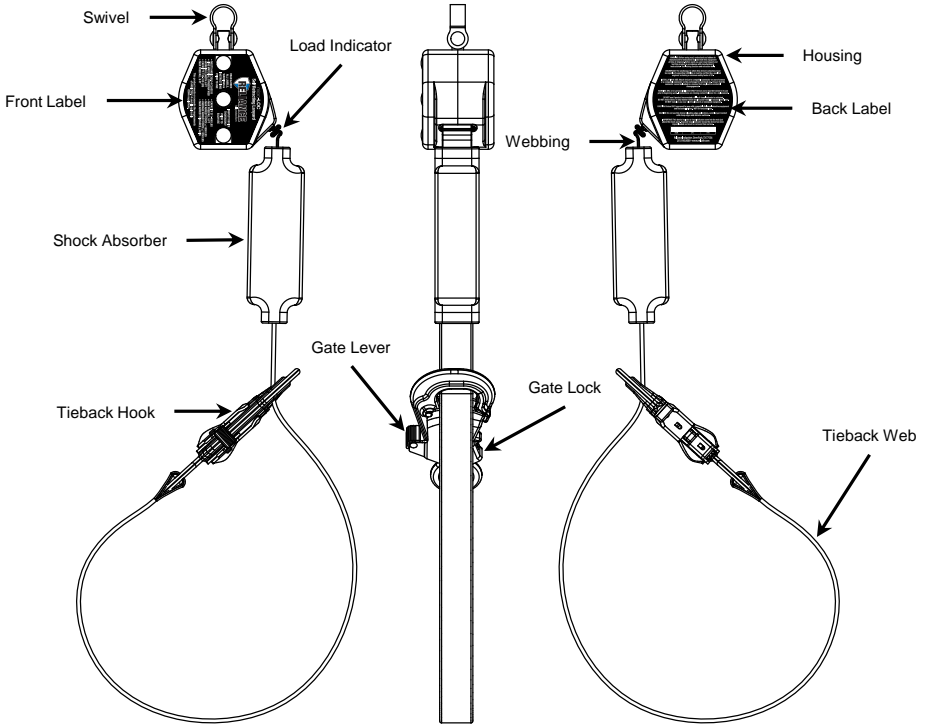

Figure 5 - 4257006-1 Single

Instructions for Use

Micro-Loc™ Product Specifications

Part #	Working Length	Line Type	Weight	SRL Type	Hook Type	Housing Type	Housing Dimensions
4255006-1	6' 1.8 m	Dyneema® Web	2.10 Lbs. 0.95 Kg	Single	3006WR Pelican III Snap Hook	ABS	3.5"x2.5"x3.4" 8.9x6.4x8.6 cm
4256006-1	6' 1.8 m	Dyneema® Web	2.85 Lbs. 1.29 Kg	Single	3011WR Lightweight Rebar Hook	ABS	3.5"x2.5"x3.4" 8.9x6.4x8.6 cm
4257006-1	6' 1.8 m	Dyneema® Web	2.50 Lbs. 1.13 Kg	Single	Steelhead Tieback Hook	ABS	3.5"x2.5"x3.4" 8.9x6.4x8.6 cm
4258006-1	6' 1.8 m	Dyneema® Web	1.75 Lbs. 0.79 Kg	Single	High Strength Aluminum Carabiner	ABS	3.5"x2.5"x3.4" 8.9x6.4x8.6 cm
4265006-1	6' 1.8 m	Dyneema® Web	4.60 Lbs. 2.08 Kg	Twin	3006WR Pelican III Snap Hook	ABS	3.5"x2.5"x3.4" 8.9x6.4x8.6 cm
4266006-1	6' 1.8 m	Dyneema® Web	6.10 Lbs. 2.77 Kg	Twin	3011WR Lightweight Rebar Hook	ABS	3.5"x2.5"x3.4" 8.9x6.4x8.6 cm
4267001-1	6' 1.8 m	Dyneema® Web	5.4 Lbs. 2.45 Kg	Twin	Steelhead Tieback Hook	ABS	3.5"x2.5"x3.4" 8.9x6.4x8.6 cm
4268001-1	6' 1.8 m	Dyneema® Web	3.90 Lbs. 1.77 Kg	Twin	High Strength Aluminum Carabiner	ABS	3.5"x2.5"x3.4" 8.9x6.4x8.6 cm

The following specifications apply to all Micro-Loc™ Self Retracting Lanyards and meet the Class B SRL requirements of ANSI Z359.14 for users from 130 lbs. to 310 lbs. (including tools and equipment) and meets OSHA requirements for users from 311 to 400 lbs. (including tools and equipment):

MAXIMUM ARREST FORCE (MAF): ≤ 1,800 lbs (8 kN)

AVERAGE ARREST FORCE (AAF): ≤ 900 lbs (6 kN)

OVERHEAD ARREST DISTANCE (AD): ≤ 24" (61 cm)

SELF RETRACTING LANYARD APPLICATION

A. PURPOSE:

Reliance Self Retracting Lanyards (SRL's) are used as one component in a personal fall arrest system (PFAS). The SRL's described in this manual meet, ANSI Z359.14 and OSHA requirements. These instructions, and markings borne by the SRL's, fulfill the instruction and marking requirements of those standards and regulations. This equipment is specifically designed to dissipate fall energy and limit the fall arrest forces that are transferred to the body.



1. PERSONAL FALL ARREST:

The Self Retracting Lanyard is used as a component of a personal fall arrest system. Personal fall arrest systems typically include a full body harness, a connecting subsystem (energy absorbing device such as a shock absorbing lanyard or Self Retracting Lanyard) and an anchorage connector. Average arresting force must not exceed 1350 lbs. (6kN) for ANSI Z359.14 and 1,800 lbs. MAF (8kN) for OSHA.

B. USE LIMITATIONS:

WARNING

*DO NOT use this device in a leading edge application. The line constituent is not designed for contact with a leading edge element. **Failure to heed this warning may result in serious injury or death.***

Consider the following application limitations before using this equipment:

1. CAPACITY:

These SRL's are designed for use by persons with a combined weight of no more than 400 lb. (180 kg.) including clothing, tools and equipment. Max. Capacity: 1 worker.

WARNING

Persons with muscular, skeletal, or other physical disorders should consult a physician before using. Pregnant women and minors must never use this equipment. Increasing age and diminished physical fitness may reduce a person's ability to withstand shock loads during fall arrest or prolonged suspension. Consult a physician if there is any question about a users physical ability to safely use this product to arrest a fall or remain suspended.

2. FREE FALL:

When anchored overhead, SRL's will limit the arrest distance to 2 ft. (61cm) or less. To avoid increased fall distances, anchor the SRL directly above the work level. Avoid working where your SRL may cross or tangle with that of another worker. Avoid working where an object may fall and strike the SRL, resulting in loss of balance or damage to the SRL. Do not allow the SRL to pass under arms or between legs. Never clamp, knot, or prevent the SRL from retracting or being taut. Avoid slack line. Do not lengthen SRL by connecting a lanyard or similar component. Do not allow free fall to exceed 6 ft. (182 cm) for users up to 310 lbs. (140 kg), including clothing, tools and equipment, and 5 ft. (152 cm) for users up to 400 lbs. (180 kg), including clothing, tools and equipment.

Instructions for Use

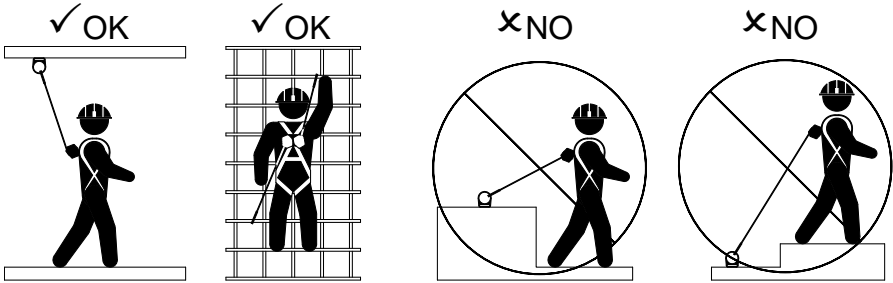

Figure 6 – Allowable Anchorages

⚠ WARNING ⚠

Do not allow the Lanyard to pass under arms or between legs. Never clamp, knot, or prevent the Lanyard from retracting or being taut. Avoid slack line. Do not lengthen the SRL by connecting a lanyard or other components without consulting Reliance. DO NOT allow the lanyard webbing to come into contact with a leading edge or any sharp, jagged serrated or abrasive edge.

3. FALL CLEARANCE:

Figures 7A through 7C illustrate fall clearance requirements. Ensure adequate clearance exists in the fall path to prevent striking an object during a fall. If a user is working at a position that is not directly below the SRL anchorage point, the clearance required and vertical fall distance increase.

Determine Fall Clearance Required: To determine the fall clearance required, measure the distance from the user's harness dorsal connection to the anchorage for the SRL. Both horizontal and vertical distances are required. Use Figures 7A through 7C to determine the required clearance. The lines in the figures represent 1 foot (30 cm) increments from the user's harness dorsal connection to the anchorage. For example, 4 ft. of clearance is required when the SRL unit is anchored 4 ft. above the users dorsal d-ring and 3 ft. to the side of the user's harness dorsal connection for users up to 310 lbs (141 kg).

⚠ WARNING ⚠

*The clearances provided here assume the fall occurs from a standing position. If the worker is kneeling or crouching an additional 3 ft (91 cm) clearance is needed. **Failure to heed this warning may result in serious injury or death.***

		Anchorage Offset From Back D-Ring												
		6'	5'	4'	3'	2'	1'	0'	1'	2'	3'	4'	5'	6'
Anchorage Level Above Back D-Ring	6'							3.0						
	5'				3.5	3.5	3.0	3.0	3.0	3.5	3.5			
	4'			4.5	4.0	3.5	3.5	3.0	3.5	3.5	4.0	4.5		
	3'		5.5	5.0	4.5	4.0	3.5	3.5	3.5	4.0	4.5	5.0	5.5	
	2'		5.5	5.0	4.5	4.0	3.5	4.0	4.0	4.0	4.5	4.5	5.0	5.5
	1'		6.0	6.0	5.5	5.0	4.5	4.0	4.0	4.0	5.0	5.0	6.0	6.0
Back D-Ring	0		7.0	6.5	6.0	5.5	4.5	4.5	4.5	5.0	6.0	6.5	7.0	
Anchorage Level Below Back D-Ring	1'		9.5	8.5	8.0	7.5	7.0	7.0	7.0	7.5	8.0	8.5	9.5	
	2'		10.5	10.0	9.0	8.0	8.0	8.5	8.5	9.0	9.0	10.0	10.5	
	3'		12.0	11.0	10.5	10.5	10.0	10.0	10.0	10.5	10.5	11.0	12.0	
	4'			12.5	12.0	11.5	11.5	11.5	11.5	11.5	12.0	12.5		
	5'				13.0	13.0	13.0	13.0	13.0	13.0	13.0			
	6'													14.0
Clearance (Feet) Between Working Surface and Nearest Obstruction (Includes SRL Extension, Free Fall, 2 Foot Safety Factor)														

FIGURE 7A

		Anchorage Offset From Back D-Ring												
		6'	5'	4'	3'	2'	1'	0'	1'	2'	3'	4'	5'	6'
Anchorage Level Above Back D-Ring	8'							3.0						
	7'				3.5	3.5	3.0	3.0	3.0	3.5	3.5			
	6'			4.5	4.0	3.5	3.5	3.0	3.5	3.5	4.0	4.5		
	5'		5.5	5.0	4.5	4.0	3.5	3.5	3.5	4.0	4.5	5.0	5.5	
	4'		5.5	5.0	4.5	4.5	4.0	4.0	4.0	4.5	4.5	5.0	5.5	
	3'		6.0	6.0	5.5	5.0	4.0	4.0	4.0	5.0	5.5	6.0	6.0	
2'		7.0	6.5	6.0	5.0	4.5	4.5	4.5	5.0	6.0	6.5	7.0		
1'		9.5	8.5	8.0	7.5	7.0	7.0	7.0	7.5	8.0	8.5	9.5		
Back D-Ring	0		10.5	10.0	9.0	9.0	8.5	8.5	8.5	9.0	9.0	10.0	10.5	
Anchorage Level Below Back D-Ring	1'		12.0	11.0	10.5	10.5	10.0	10.0	10.0	10.5	10.5	11.0	12.0	
	2'			12.5	12.0	11.5	11.5	11.5	11.5	11.5	12.0	12.5		
	3'				13.0	13.0	13.0	13.0	13.0	13.0	13.0			
	4'													14.0
	5'													
	6'													
Clearance (Feet) Between Working Surface and Nearest Obstruction (Includes SRL Extension, Free Fall, 2 Foot Safety Factor)														

FIGURE 7B

All non-tieback models.

⚠ WARNING ⚠

DO NOT make any connection that are not specifically shown on Figures 7A, 7B or 7C. Allowed connections will show a fall clearance distance in the box, all dark grey boxes are not allowed. **Failure to follow this procedure could result in serious injury or death.**

Tieback

Configuration:

Tieback snap hook to anchor, direct connection.

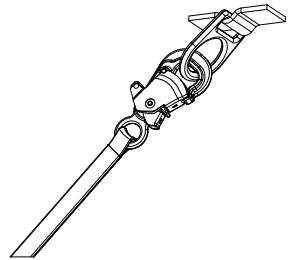

⚠ WARNING ⚠

When direct connecting the tieback hook to an anchorage, DO NOT attach to any anchorage lower than 4' below the back D-Ring. Doing so would increase free fall distance to greater than 6'. **Failure to follow this procedure could result in serious injury or death.**

Instructions for Use

		Anchorage Offset From Back D-Ring												
		6'	5'	4'	3'	2'	1'	0'	1'	2'	3'	4'	5'	6'
Anchorage Level Above Back D-Ring	6'						3.0							
	5'				3.5	3.5	3.0	3.0	3.0	3.5	3.5			
	4'			4.5	4.0	3.5	3.5	3.0	3.5	3.5	4.0	4.5		
	3'		5.5	5.0	4.5	4.0	3.5	3.5	3.5	4.0	4.5	5.0	5.5	
	2'		5.5	5.0	4.5	4.0	3.5	4.0	4.0	4.0	4.5	4.5	5.0	5.5
	1'		6.0	6.0	5.5	5.0	4.5	4.0	4.0	4.0	5.0	5.0	5.5	6.0
Back D-Ring	0	7.0	6.5	6.0	5.5	4.5	4.5	4.5	5.0	6.0	6.5	7.0		
Anchorage Level Below Back D-Ring	1'		9.5	8.5	8.0	7.5	7.0	7.0	7.0	7.5	8.0	8.5	9.5	
	2'		10.5	10.0	9.0	8.0	8.5	8.5	8.5	9.0	9.0	10.0	10.5	
	3'		12.0	11.0	10.5	10.5	10.0	10.0	10.0	10.5	10.5	11.0	12.0	
	4'			12.5	12.0	11.5	11.5	11.5	11.5	11.5	12.0	12.5		
	5'				13.0	13.0	13.0	13.0	13.0	13.0	13.0			
	6'													14.0
Clearance (Feet) Between Working Surface and Nearest Obstruction (Includes SRL Extension, Free Fall, 2 Foot Safety Factor)														

FIGURE 7C

Tieback Configuration:

Tieback snap hook to

web around anchorage

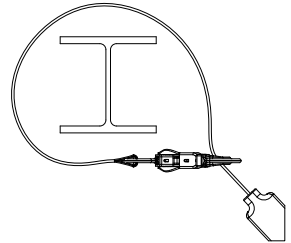

4. SWING FALLS:

Swing falls occur when the anchorage point is not directly above the point where a fall occurs (see Figure 8). The force of striking an object in a swing fall may cause serious injury. In a swing fall, the total vertical fall distance will be greater than if the user had fallen directly below the anchorage point, thus increasing fall clearance required to safely arrest the user. Use Figures 7A through 7C to determine the fall clearance for your application. Minimize swing falls by working as directly below the anchorage point as possible. Never permit a swing fall if injury could occur.

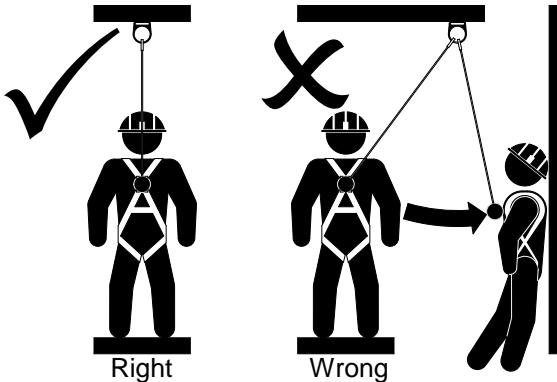

Figure 8



5. CHEMICAL HAZARDS:

Acidic, alkaline, or other environments with harsh substances may damage the webbing and hardware elements of this SRL. If working in a chemically aggressive environment contact Reliance engineering to verify compatibility.

6. HEAT:

Do not use SRL's that utilize a web lanyard in environments with temperatures greater than 185°F (85°C). Protect the lanyard when used near welding, metal cutting, or other heat producing activities. Sparks may damage the lanyard and reduce its strength.

***IMPORTANT:** When working with tools, materials, or in high temperature environments, ensure that associated fall protection equipment can withstand high temperatures, or provide protection for those items.*

7. CORROSION:

Do not expose the device to corrosive environments for prolonged periods. Organic substances and salt water are particularly corrosive to metal parts. When working in a corrosive environment more frequent inspection, cleaning, and drying of the SRL is required. See Care and Inspection sections for cleaning and inspection details.

8. ELECTRICAL HAZARDS:

Use extreme caution when working near energized electrical sources. Metal hardware on the SRL will conduct electric current. Maintain a safe working distance [preferably at least 10' (3m)] from electrical hazards.

9. MOVING MACHINERY:

When working near moving machinery parts (e.g. conveyors, rotating shafts, presses, etc.), make sure that loose equipment is secured. Maintain a safe working distance from machinery that could entangle clothing, the lanyard, the harness, or other components connected to it.

10. SHARP EDGES AND ABRASIVE SURFACES:

Do not expose lanyards to sharp edges or abrasive surfaces that could cut, tear, abrade, or damage the webbing. If working around sharp edges and abrasive surfaces is unavoidable use heavy padding or other protective barriers to prevent direct contact.

11. WEAR AND DETERIORATION:

Any SRL which shows signs of excessive wear, deterioration or aging, must be removed from use and marked "UNUSABLE" until destroyed. See detailed inspection procedures.

12. IMPACT FORCES:

Any SRL that has been subjected to the forces of arresting a fall must be immediately removed from service and marked as "UNUSABLE" until

Instructions for Use

it has been destroyed. Micro-Loc™ SRL's have impact load indicators built into webbing that facilitate inspection for fall loading.

SYSTEMS REQUIREMENTS

A. COMPATIBILITY OF SYSTEM PARTS

1. COMPATIBILITY OF COMPONENTS AND SUBSYSTEMS:

Reliance SRL's are designed to be used with Reliance approved components and connecting subsystems. Use of the SRL with products made by others should be evaluated by a competent person to ensure compatibility of components and hardware. Connecting subsystems must be suitable for use in the application (e.g. fall arrest or restraint). Reliance manufactures a line of connecting subsystems for most applications. Contact Reliance for further information. Refer to the manufacturer's instructions supplied with the component or connecting subsystem to determine suitability. Contact Reliance with any questions regarding compatibility of equipment used with the SRL.

2. COMPATIBILITY OF CONNECTORS

Connectors, such as D-rings, snap hooks, and carabiners, must be rated at 5,000 lb. (22 kN) minimum breaking strength and comply with ANSI Z359.12. Reliance connectors meet these requirements. Connecting hardware must be compatible in size, shape, and strength. Non-compatible connectors may accidentally disengage ("rollout") or false engage. Always verify that the connecting snap hook or carabiner and the D-ring on the harness or anchorage connector is compatible. Some harness models have web loop connection points. Do not use snap hooks to connect to web loops unless the snap hook complies with ANSI Z359.12. A self-locking carabiner may also be used to connect to a web loop. Ensure the carabiner cannot cross-gate load (load against the gate rather than along the backbone of the carabiner). Connecting subsystems (Self Retracting Lanyard, lanyard, rope grab and lanyard, cable grab, etc.) must be suitable for your application.

EXAMPLES OF INAPPROPRIATE CONNECTIONS :

- a) To a D-ring to which another connector is attached
- b) In a manner that would result in a load on the gate.
- c) In a false engagement, where features that protrude from the snap hook or carabiner catch on the anchor and seem to be fully engaged to the anchor point.(Reliance has designed the width of the head and gates of Reliance snap hooks to prevent this issue in most D-rings.)
- d) Snap hooks attached to each other.

- e) Directly to webbing or rope lanyard or tie-back.
- f) To any object shaped such that the snap hook or carabiner will not close and lock, or that could cause roll-out should a fall occur.
- g) Connecting a lanyard or other lengthening device to the snap hook.

3. ANCHORAGES AND ANCHORAGE CONNECTORS

Anchorage for personal fall arrest systems must have a strength capable of supporting a static load, applied in directions permitted by the system, of at least: (a) 3,600 lb. (16 kN) when certification exists, or (b) 5,000 lb. (22 kN) in the absence of certification. When more than one personal fall arrest system is attached to an anchorage, the anchorage strengths set forth in (a) and (b) must be multiplied by the number of systems attached to the anchorage. This requirement is consistent with OSHA requirements under 29 CFR 1910 & 1926.

Anchorage connectors must be selected carefully. Eyebolts should not be used if they will be loaded at an angle to their axis, unless the loads fall within design parameters for such use. Weld-on lugs should not be less than 1/2 in (12.7mm) in width and should not be made of steel with less than 50,000-PSI (34 Mpa) yield strength. The proper stress areas and weld areas must be calculated to assure proper safety. If in question, consult Reliance Engineering for proper design requirements.

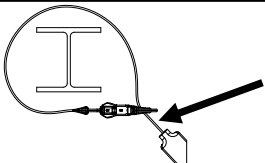
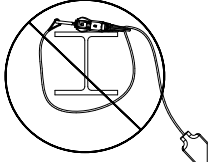
⚠ WARNING ⚠	
<p><i>DO NOT connect the Tie-Back Snap Hook above the Shock Absorber. Connect only to the designated tieback web. Failure to connect only to Tie-Back web of the SRL may result in serious injury or death.</i></p>	 <p>A diagram showing a tie-back web with a snap hook attached to it. An arrow points to the connection point, indicating it is the correct method.</p>
<p><i>DO NOT connect the Tie-Back Snap Hook in any manner that will result in the gate or snap hook being loaded against the anchorage. Loading the gate or hook against the anchorage may result in serious injury or death.</i></p>	 <p>A diagram showing a tie-back web with a snap hook attached to it. A diagonal line is drawn over the connection, indicating it is incorrect because the gate or hook is being loaded against the anchorage.</p>

INSTALLATION PROCEDURE

A. CONNECTING SINGLE SRL TO A FIXED ANCHOR POINT

NOTE: Approved fall protection must be worn during Micro-Loc™ Self-Retracting Lanyard installation at all times. Do not use the SRL as a method of personal fall protection until the system has been completely installed, inspected, and approved for use by a Qualified Person.

Instructions for Use

1. Installation of the Micro-Loc™ Self-Retracting Lanyard begins with the identification of a suitable anchor point. The anchor point must be capable of supporting a 3,600 lb (16 kN) load where certification of load carrying ability exists, or 5,000 lb (22 kN) where certification does not exist. NOTE: These strengths must be multiplied by the number of persons that will be connecting to the anchorage point at any one time.
2. Pass a large carabiner or bow shackle (or other Reliance approved connecting means) through the swivel eye at the top of the Micro-Loc™. This carabiner or bow shackle must be rated with a minimum breaking strength of at least 5,000 lb (22 kN) and must be used for connecting to only 1 SRL at a time.
3. Secure the bow shackle or carabiner to the anchor point. If using bow shackle, verify that it is a safety shackle and that the nut of the shackle has been fully captured using a clevis pin or lock ring to prevent accidentally disengagement. When using a carabiner make sure that the gate has fully closed and rotated into a locked position.

B. CONNECTING SINGLE SRL TO A HARNESS D-RING

1. Pass a large carabiner (or other Reliance approved connecting means) through the swivel eye at the top of the Micro-Loc™. This carabiner or bow shackle must be rated with a minimum breaking strength of at least 5,000 lbs. (22 kN) and must be used for connecting to only 1 SRL at a time.
2. Connect the carabiner to the dorsal d-ring of the harness.

C. CONNECTING SINGLE OR TWIN SRL'S TO A HARNESS LOOP

42XXXXX Series Micro-Loc™ SRL'S can be connected directly to the harness webbing at the dorsal D-Ring location utilizing the 3020 Mounting Bracket (Figure 9A).

1. Depress the lock button on the end of the locking pin then pull the pin into the open position (Figure 9B).
2. Slide the open end of the 3020 Mounting Bracket through the swivel loop on the first Micro-Loc™ SRL (Figure 9C). Then repeat for the second SRL if necessary (Figure 9D).
3. Pull both webbing shoulder straps in the back D-ring into a loop away from the black back plate. Create a loop large enough to allow insertion of the locking pin (Figure 9E).
4. Align the locking pin with the sewn in loop at the dorsal D-ring location on the harness (Figure 9F).
5. Depress the lock button and slide the pin through the webbing loop and then through the end of the mounting bracket frame (Figure 9G).

6. Release the lock button and attempt to pull open. If the mounting bracket opens, repeat step five. Repeat the attempt to open the mounting bracket. If the bracket pulls open remove the bracket from service immediately and replace with a new one.

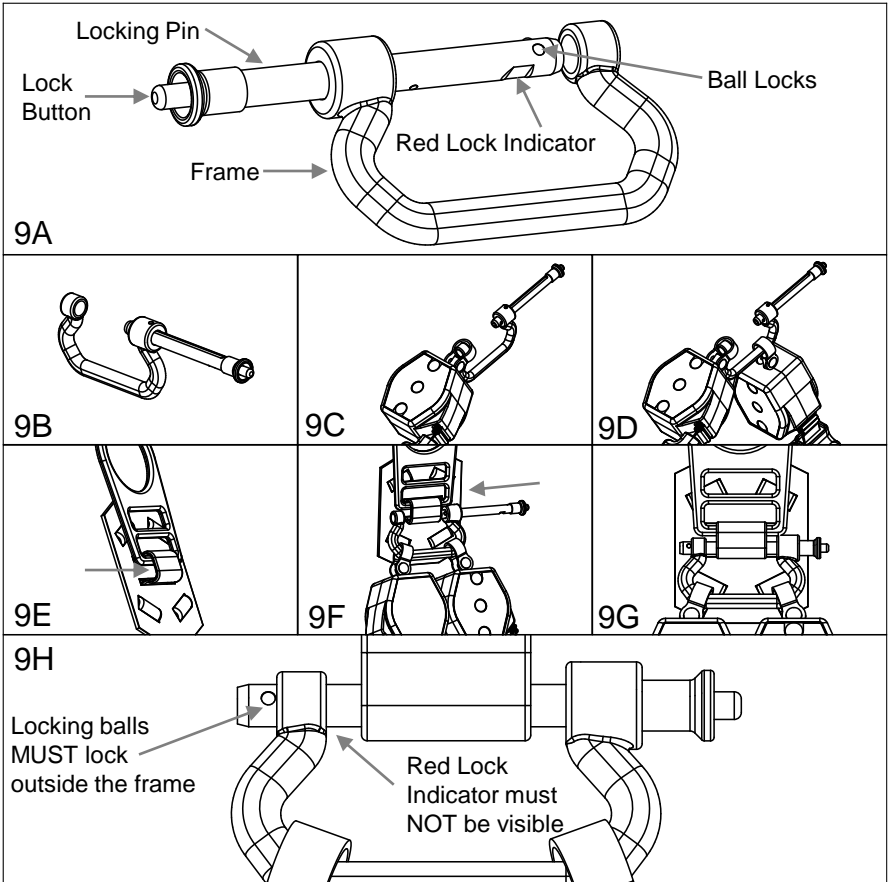

Figure 9

⚠ WARNING ⚠

The locking balls must pass through the open end of the Mounting Bracket and lock and there must be no red safety indicator showing. Failure to follow this procedure could result in serious injury or death.

Instructions for Use

D. PREPARATION FOR USE

1. Once the Micro-Loc™ has been secured into position, extract a few feet of web slowly to verify that there is tension on the line and the retraction spring is functioning correctly.
2. Grasp the web above the load indicator (Figure 10) and give the web a quick, sharp tug. The unit should lock, this ensures that the locking mechanism is operating.

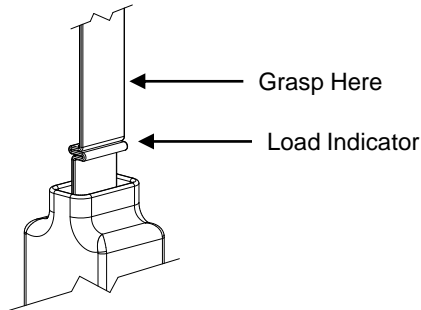

Figure 10

E. INSPECT PRIOR TO USE:

Before the use of this SRL, inspect the SRL and all components of the PFAS:

1. Inspect the SRL to verify that it is in serviceable condition. Examine every inch of the webbing for severe wear, cuts, burns, frayed edges, abrasion, or other damage. Examine stitching for any pulled, loose, or torn stitches. See Inspection section for details.

⚠ WARNING ⚠

DO NOT USE if any unsafe condition is found! Always err on the side of caution.

F. PLAN SCOPE OF WORK TO BE PERFORMED (JOB SAFETY TASK ANALYSIS)

Plan procedures to safely perform tasks when using any components of a PFAS. Some considerations are listed below (see APPLICATIONS, item B. USE LIMITATIONS section for additional details)

1. Anchorage Selection. In addition to strength considerations, the anchorage should be rigged to prevent a fall onto the structure when considering 2 and 4 below.
2. Swing pendulum fall (see Figure 8).
3. Rough surfaces or unprotected sharp edges that could cut or abrade the equipment if unprotected.

4. Workplace Geometry

- a) Free fall distance - Personal fall arrest systems used with this equipment should be mounted overhead in such a way as to eliminate the possibility of a free fall.
- b) Deceleration distance - See Clearance Charts for fall clearances
- c) Total fall distance - See Clearance Charts for fall clearances
- d) A careful examination must be made of the workplace by a Competent Person before the selection or installation of Micro-Loc™ anchorage points. Consideration must be given both to the movement of materials (Will cranes be used to “fly” equipment or parts in?) and workers around the workplace to ensure that potentially hazardous situations are avoided.
- e) Areas where overhead cranes or gantries are used must be examined to verify that neither the moving loads or lifting wires can interfere or snag the extended webbing of a Micro-Loc™ SRL causing a worker to be dislodged.
- f) Overhead lighting and electrical cables must also be identified to insure that installation of the SRL is sufficiently far enough away to prevent an electrocution hazard.
- g) Consideration of obstacles present in the work area must include ALL locations that COULD be reached if the entire length of the web were extracted from the SRL. Obstacles that pose no threat when a worker is on a platform, for example, may be exposed to a dangerous situation should the worker climb downwards or moves laterally towards another work surface.
- h) Avoid installations where debris, contaminants, & other objects falling from above could damage the Micro-Loc™ and/or its webbing.
- j) Extreme caution must also be exercised when considering the use of the Micro-Loc™ SRL as a means of fall protection in areas where a user is working on a sloped surface such as a pitched roof or tank bottom, or on piles of loose material (such as grain or sand) that may shift or slide. If the user falls or begins to slide on such a surface, the Micro-Loc™ SRL may not be extracted fast enough for the device to lock-up (typically, the line must be extracted around 5-6 ft/sec (150-180 cm/sec). for the unit to lock-up,) and arrest the sliding fall. The user might continue to slide over a roof edge, or into some other hazardous zone causing injury or death. The use of a travel restriction system or a work-positioning system may be more appropriate for such locations and should be considered first. Contact Reliance Engineering for help in selecting equipment for these applications.

5. Rescue and Evacuation

The user and employer must have a rescue plan in place, training in its use, and the means to implement it at hand. The employer must have the ability to perform a rescue quickly and safely. Do not plan to rely on others for rescue because prolonged suspension can cause bodily injury or death.

Instructions for Use

CARE OF THE MICRO-LOC™ SRL

A. Clean exterior by wiping away excess dirt, grease, or other materials that might interfere with operation of the unit. Dry hardware with a clean, dry cloth, and hang to air dry. Do not attempt to disassemble the unit. A buildup of dirt, solvents, paint, etc. on the Lanyard may prevent the SRL from working properly, and should be removed from service. More information on cleaning is available from Reliance. If you have questions concerning the condition of your SRL, or have any doubt about putting it into service contact Reliance.

B. Store SRL's in a cool, dry, clean environment. Avoid areas where heat, oil, chemicals or their vapors may exist. Thoroughly inspect after extended storage. Good safety practice requires separate storage of unusable product from usable product.

INSPECTION

A. INSPECTION FREQUENCY

1. The SRL must be fully inspected by the user prior to each use.
2. A competent person other than the user must inspect the SRL in accordance with ANSI Z359.14 as specified in the following inspection schedule.

Record the results of each formal inspection in the inspection and maintenance log as described.

ANSI Z359.14 Inspection Schedule			
Type of Use	Application Examples	Conditions of Use	Inspection Frequency
Frequent to Light	Rescue and Confined Space, Factory Maintenance	Good Storage Conditions, Indoor or Infrequent Outdoor Use, Room Temperature, Clean Environments	Annually
Moderate to Heavy	Transportation, Residential Construction, Utilities, Warehouse	Fair Storage Conditions, Indoor and Extended Outdoor Use, All Temperatures, Clean or Dusty Environments	Semi-Annually to Annually
Severe to Continuous	Commercial Construction, Oil & Gas, Mining	Harsh Storage Conditions, Prolonged or Continuous Outdoor Use, All Temperatures, Dirty Environments	Quarterly to Semi-Annually

B. INSPECTION PROCEDURE

1. Prior to each use, the worker must inspect the Micro-Loc™ Self-Retracting Lanyard for any physical damage, wear, corrosion, or malfunctioning parts. Verify that the load indicator is not deployed by looking to see if the red tag with the words “REMOVE FROM SERVICE” is exposed (Figure 11). Once the load indicator has been deployed, the SRL must be removed from service as the SRL is not repairable.

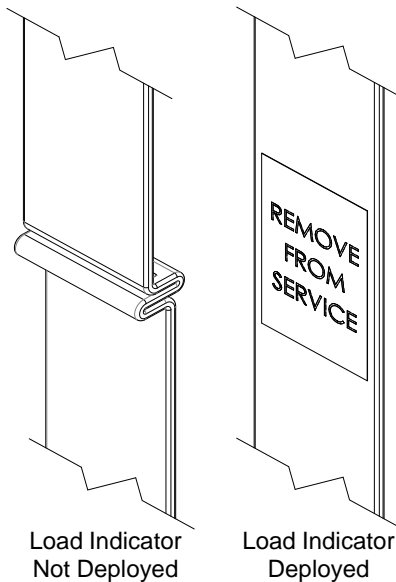

Figure 11

2. The worker should also verify that conditions around the SRL location have not changed that may affect its' ability to arrest a fall, such as obstacles or equipment directly below the anchorage point which might create a swing fall.

3. Before every use, the worker should extract all of the webbing and examine it for defects that would affect its overall strength. These defects would include but are not limited to weld strikes or burns, fraying, bulge spots, cuts, etc. If the webbing is showing evidence of any of these defects, the unit should be removed from service immediately as this unit is not serviceable.

4. After the webbing has been allowed to retract into the unit, the webbing should be grasped above the load indicator (see Figure 10) and pulled sharply to verify proper lockup of the unit. If unit fails to lockup when pulled quickly, or if the webbing fails to retract properly after lockup, the unit must be removed from service.

Instructions for Use

5. Carefully inspect the plastic housing for cracks or fractures. Evidence of cracks or fractures requires factory-authorized inspection. Scuffing and minor indentations that do not inhibit the retraction of the unit are cosmetic issues.

TRAINING

It is the responsibility of the employer to train all workers prior to using this system (per OSHA 1926.503 (a)(1)). The employer shall provide a training program for each employee who might be exposed to fall hazards. The program shall enable each employee to recognize the hazards of falling and shall train each employee in the procedures to be followed in order to minimize these hazards. The employer shall assure that, as necessary, each employee has been trained by a competent person qualified in the following areas:

1. OSHA regulations governing the use of horizontal lifelines.
2. Ability to recognize potential fall and workplace hazards.
3. Method of inspection of safety equipment.
4. Rescue procedures.
5. Installation and removal techniques.

RESCUE PLANNING

Prior to system use, a rescue plan must be prepared, the workers must be trained in its use, and the rescue equipment must be on hand to implement it in case of a fall. Typical rescue plans include (but are not limited to) the following items:

1. List of equipment that must be readily accessible in the event of an emergency and the names of those workers certified to use or operate that equipment.
2. Emergency contact phone numbers (ambulance, hospital, fire department...) and a means to contact them (cell phone, emergency radio).
3. List of employees on the site, and the specific tasks they will perform to effect the rescue.
4. The equipment that will be used to aid in the rescue of any worker should be attached to structural anchorages independent of those used for the personal fall arrest system. During installation of anchorages, tie-off and equipment attachment hard points should be attached, and also clearly marked in such a manner as to provide a means to rescue a worker in any position along the worksite.



SERVICING

Micro-Loc™ SRL's are not repairable. If the SRL has been subjected to fall arrest forces or inspection reveals an unsafe or defective condition, remove the SRL from service, mark "UNUSABLE", and dispose of the unit.

GUARDING AGAINST APPLICATION FAILURE

To avoid property damage, injury or death, the user must take reasonable steps to prevent "Application Failure". An application failure may be any unacceptable use, misuse, or application error on the part of the user or system designer. Because each end user might use this product in a manner different from Reliance testing platform, and because the user might use this product in combination with other manufacturer's products in a manner not evaluated, contemplated, or tested by Reliance, the user or system designer is ultimately responsible for verifying or validating the suitability and compatibility of this product for use in his application or system. Whenever questions regarding proper use or compatibility arise, please contact Reliance Engineering at (303) 424-8650.

WARNINGS AND LIMITATIONS

1. Proper care should always be taken to visually scan the work area prior to use. Remove any obstruction, debris, and other materials from, and beneath the work area that could cause injuries or interfere with the operation of this system. Be cautious of swing fall hazards if working anywhere but directly below the anchorage point of the SRL. Be aware of the movements of others using SRL's or shock-absorbing lanyards in close proximity, knowing that if the lines become crossed or tangled and a fall occurs, the sudden motion could pull others off balance and make rescue more difficult.
2. Do not release the webbing when extended and allow it to retract back into the unit uncontrollably. Releasing the webbing and allowing it to reel itself in uncontrollably could cause damage to the Micro-Loc™. The webbing should be allowed to retract slowly into the unit under its' own power.
3. In the course of use, do not allow the webbing to wrap around arms or legs, or become entangled in clothing or other items. In the event of a fall, they could cause injury, or prevent the Micro-Loc™ SRL from functioning properly. Any Micro-Loc™ Self Retracting Lanyard that has the load indicator showing "REMOVE FROM SERVICE" has seen a fall-arrest load and must be removed from service, mark "UNUSABLE", and dispose of the unit. Micro-Loc™ SRL's are not repairable.

Instructions for Use

- Users should be familiar with pertinent regulations governing the use of this personal fall arrest system and its components. Only trained and competent personnel should install and supervise the use of this system.
- Use only Reliance supplied or qualified compatible components.
- Do not tie knots in the webbing of the unit. Tying knots in webbing reduces the overall strength of the webbing. Do not cross lines with another worker. Should the lines become entangled, a fall by one worker could dislodge others.

LABELING

The illustrations here are representations of the actual labels that appear on Reliance Micro-Loc™ Self Retracting Lanyards.

All the information on the SRL Specifications Label is important for the safe use of this product, so the user should ensure that the label has not been removed and that the descriptions it contains match the task and environment in which the product is intended to be used. An inspection log is available on page 26 of this manual. The unit should be inspected by a Competent Person at periodic intervals and at least monthly. As per these instructions, the unit should be tested for locking before each use.

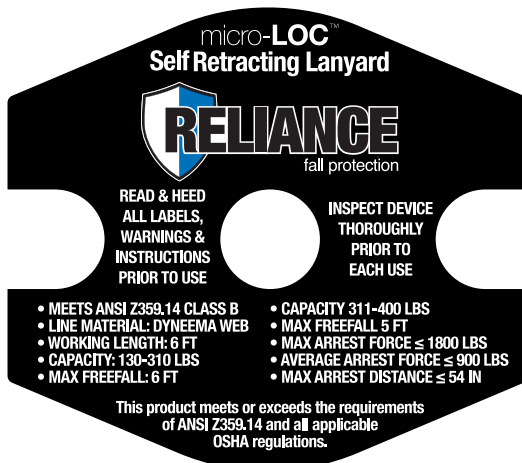

Figure 12A Front Label



WARNING: Before using read, understand and adhere to manufacturer's instructions included with this equipment at time of shipment. Before each use, user must inspect and test this product in accordance with manufacturer's instructions. Test locking function and retraction daily.

ANCHORAGE: The anchorage, to which this device is attached, must be capable of supporting 5,000 lbs or must be certified by a qualified engineer as having a minimum safety factor of 2:1.

INSTALLATION & USE: Attach device to compatible connector on users harness or a compatible connector on the anchorage for overhead use. Ensure that the connector cannot be loaded in a manner that may lead to accidental disengagement.

WARNING: SRL is for personal fall arrest ONLY! Device users must be trained in its use prior to beginning work. If instructions are missing contact Reliance for a replacement.

DO NOT use if product has arrested a fall or if visual indicator is activated. **DO NOT** attach device in any manner which would cause freefall to exceed listed limits. **DO NOT** install or use near electrical hazards or energized equipment.

CAUTION: Device ONLY approved for use with compatible Reliance Industries equipment and horizontal lifelines. NOT for horizontal use.

CAUTION: Do not use this device in leading edge applications, avoid lanyard contact with sharp edges and abrasive surfaces.

IMPORTANT: This device includes a visual indicator sewn into the web just above the shock pack. Exposed visual indicator shows the device has been impact loaded and must be removed from service.

DOM	S/N	P/N
-----	-----	-----

Reliance Industries Deer Park, TX 77536
281.930.8000 • www.relsafe.com

Figure 12B Back Label

!WARNING!
No Tie-Back or Leading Edge Contact
Between Energy Absorber & Housing

Figure 12C Tieback Label
(Models #'s 4257006-1 and 4267006-1)

Instructions for Use

NOTES



EQUIPMENT RECORD

PART NUMBER	
SERIAL NUMBER	
DATE MANUFACTURED	
PURCHASE DATE	
ASSIGNED TO	

SPECIFICATIONS

Certified to meet the current ANSI Z359.14 and OSHA regulations for the Self Retracting Lanyard component of a complete personal fall arrest system. All hardware certified to 5000 lb. (22kN) breaking strength, 100 percent proof tested to 3600 lbs. (16.5kN).

Individual serial number and date of manufacture are on product label.

Made in Texas, USA

INSPECTION RECORD

DATE	INSPECTOR	PASS/FAIL

Instructions for Use

These Instructions Apply to the Following Part Numbers:

4255006-1
4256006-1
4257006-1
4258006-1
4265006-1
4266006-1
4267006-1
4268006-1

Warranty

Products manufactured by Reliance Industries LLC are warranted against factory defects in workmanship and materials for a period of two years from date of purchase by the owner (end user) or for a period of one year from date first used, provided that this period shall not exceed two years from date of shipment to distributor. Upon notice of product defect or fault, Reliance Industries LLC will promptly repair or replace all defective items. Reliance Industries LLC reserves the right to elect to have any defective item returned to its manufacturing plant, authorized service center or distributor for inspection before making a repair or replacement. This warranty does not cover equipment damages or defects resulting from abuse, damage in transit, or other damage beyond the control of Reliance Industries LLC. This warranty applies only to the original purchaser and is the only one applicable to our products and services, and is in lieu of all other warranties, expressed or implied. When products offered by Reliance Industries LLC are manufactured by a third party. Original equipment manufacturer (OEM) warranty shall apply and may be outside the control of Reliance Industries LLC.



Reliance Industries
P.O. Box 2046
Deer Park, TX 77536
Phone : 281-930-8000
Toll Free : 888-362-2826
Fax : 281-930-8666
www.relsafe.com

Copyright 2019 Reliance Fall Protection
4200000-100 Rev A